



Instruction Manual

Fun Pop 8oz. Popper

Model No. 2408, 2408BKG, 2408EX





GOLD MEDAL® PRODUCTS CO.

10700 Medallion Drive, Cincinnati, Ohio 45241-4807 USA





SAFETY PRECAUTIONS

	⚠ DANGER
	<p>Machine must be properly grounded to prevent electrical shock to personnel. Failure to do so could result in serious injury, or death. Do NOT immerse any part of this equipment in water. Do NOT use excessive water when cleaning. Keep cord and plug off the ground and away from moisture. Always unplug the equipment before cleaning or servicing.</p> <p style="text-align: right;">008GEND1112</p>

	⚠ DANGER
	<p>Improper installation, adjustment, alteration, service or maintenance can cause property damage, injury or death. Any alterations to this equipment will void the warranty and may cause a dangerous condition. NEVER make alterations to this equipment. Read the Installation, Operating, and Maintenance Instructions thoroughly before installing, servicing, or operating this equipment. Make sure all machine switches are in the OFF position before plugging the equipment into the receptacle.</p> <p style="text-align: right;">014GEND1112</p>

	⚠ WARNING
	<p>To avoid burns, do NOT touch the kettle or any heated surface. Do NOT place or leave objects in contact with heated surfaces.</p> <p style="text-align: right;">013PW1112</p>

	⚠ WARNING
	<p>ALWAYS wear safety glasses when servicing this equipment.</p> <p style="text-align: right;">010GENW1112</p>

	⚠ CAUTION
	<p>Do NOT allow direct contact of this equipment by the public when used in food service locations. Only personnel trained and experienced in the equipment operation may operate this equipment. Carefully read all instructions before operation.</p> <p style="text-align: right;">012GENC1112</p>

	⚠ CAUTION
	<p>This machine is NOT to be operated by anyone under the age of 18.</p> <p style="text-align: right;">007GENC1112</p>

NOTE: Improvements are always being made to Gold Medal's equipment. This information may not be the latest available for your purposes. It is critical that you call Gold Medal's Technical Service Department at 1-800-543-0862 for any questions about your machine operations, replacement parts, or any service questions. *(Gold Medal Products Company does not assume any liability for injury due to careless handling and/or reckless operation of this equipment.)*

INSTALLATION INSTRUCTIONS

Inspection of Shipment

Unpack all cartons and check thoroughly for any damage that may have occurred during transit. Damage claims should be filed immediately with the transportation company.

Setup



Your new Popper is completely assembled and tested at the factory. Remove all packing material and tape before starting operation.

Electrical Requirements

The following power supply must be provided:

2408: 120 Volts, 1053 Watts, 60Hz,

2408EX: 230 Volts, 1053 Watts, 50Hz

 DANGER	
	<p>Machine must be properly grounded to prevent electrical shock to personnel. Failure to do so could result in serious injury, or death.</p> <p>Do NOT immerse any part of this equipment in water.</p> <p>Do NOT use excessive water when cleaning.</p> <p>Keep cord and plug off the ground and away from moisture.</p> <p>Always unplug the equipment before cleaning or servicing.</p>

Your electrician must furnish sufficient power for proper machine operation. We recommend this equipment be on a dedicated and protected circuit. Failure to wire properly will void the warranty and may result in damage to the machine. It is Gold Medal Products Company's recommendation that this machine be plugged directly into a wall outlet. The use of extension cords is not recommended due to safety concerns, and may cause sacrificed and/or reduced performance.

Before You Plug In Machine

1. Make sure all machine switches are in the OFF position before plugging the equipment into the receptacle.
2. Make sure the wall outlet can accept the grounded plugs (where applicable) on the power supply cord.
3. The wall outlet must have the proper polarity. If in doubt, have a competent electrician inspect the outlet and correct if necessary.
4. **DO NOT** use a grounded to un-grounded receptacle adapter.
5. Install the unit in a level position.



OPERATING INSTRUCTIONS

Controls and Their Functions

LIGHT/WARMER SWITCH

This switch heats the bottom of the corn pan and turns on the light.

KETTLE MOTOR SWITCH

This switch turns on the motor which drives the kettle agitator shaft.

KETTLE HEAT SWITCH

This switch turns on the heat element inside the popcorn kettle.

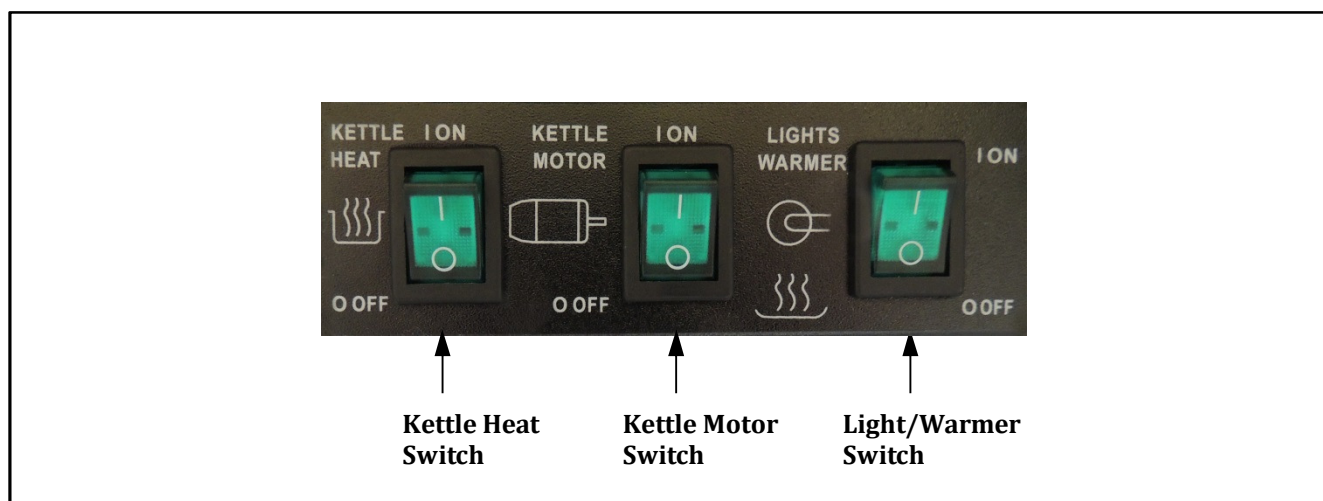

Amount of Popcorn and Oil

Your new popper is equipped with a corn measure cup. Popcorn popped in coconut oil stays fresher longer. Coconut oil does not leave black deposits in your kettle like other oils.

Corn charge: 8 oz.
Oil charge: 2.6 oz.
Flavacol: 1 tablespoon

4 Oz. Accessory Pack

Part No. 2071NM: Scoop
Part No. 47147: One Cup Measure
Part No. 47678: Flavacol Measure 6.5cc
Part No. 47150: Oil Measure (1/3 Cup)



CARE AND CLEANING

1. Each time you finish a series of popping, wipe the outside of the kettle with a soft cloth to remove any oil drippings on the outside of the kettle.

CAUTION: The hot kettle will cause burns if you touch it with your hand. Allow the kettle to cool for at least 1 hour before attempting to clean.

2. After you finish popping for the day, allow kettle to cool until it is not too hot to handle, but still warm.
3. Unplug kettle and remove it from the machine.
4. With a cloth, wipe out the inside of the kettle, kettle lid, crossbar, outside and underneath of the kettle.

DO NOT place the kettle in water. This will cause damage to the electrical components and will void your warranty.

5. Cleaning the cabinet of your machine is easy. Take a clean cloth and wipe excess grease from the glass. Wipe the outside of the machine also.

NOTE: Ammonia cleaners will damage the plastic doors. Use only non-ammonia cleaners, such as Gold Medal Watchdog Glass Cleaner (Item No. 2588).

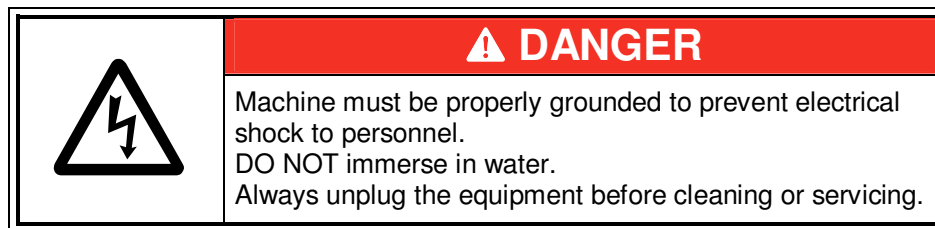

Good sanitation practice demands that all food cooking equipment be cleaned regularly. A clean looking, well-kept machine is one of the best ways of advertising your product.



REPLACING BROKEN GLASS

If you accidentally break a panel of glass, it can be replaced very easily. Gold Medal Products does not ship glass. Obtain from local glass shop and always purchase tempered glass.

1. Remove dome from machine.
2. Remove all loose pieces of glass.
3. Remove all rigid glass channels from around the glass to be replaced. Set it aside as it must be reused.
4. Carefully remove the rest of broken glass.
5. Apply decals (if desired) to the new glass panel.
6. Slide rigid glass channels over the exposed sides and bottom.
7. Slide new glass back into machine, and reattach the dome.

Glass Dimensions:

22 3/16" X 16 1/2" X 1/8" (Three glass panels per unit)



MAINTENANCE INSTRUCTIONS

	⚠ DANGER
	Improper installation, adjustment, alteration, service, or maintenance can cause property damage, injury or death. Read the installation, Operating, and Maintenance Instructions thoroughly before installing or servicing this equipment.

	⚠ DANGER
	Do Not immerse the equipment in water. Unplug your machine before servicing.

	⚠ WARNING
	Adequate eye protection must be used when servicing this equipment to prevent eye injury.

	⚠ CAUTION
	THE FOLLOWING SECTIONS OF THIS MANUAL ARE INTENDED ONLY FOR QUALIFIED SERVICE PERSONNEL WHO ARE FAMILIAR WITH ELECTRICAL EQUIPMENT. THESE ARE NOT INTENDED FOR THE OPERATOR.



ORDERING SPARE PARTS

1. Identify the needed part by checking it against the photos, illustrations, and/or parts list.
2. When ordering, please include part number, part name, and quantity needed.
3. Please include your model number, serial number, and date of manufacture (located on the machine nameplate) with your order.
4. Address all parts orders to:

Parts Department
Gold Medal Products Co.
10700 Medallion Drive
Cincinnati, Ohio 45241-4807

Or, place orders by phone or online:

Phone: (800) 543-0862
(513) 769-7676

Fax: (800) 542-1496
(513) 769-8500

E-mail: info@gmpopcorn.com

Web Page: www.gmpopcorn.com



Cabinet Exterior – Front View



Item	Part No.	Model(s)	Part Description	Qty.
1	58001	2408, 2408EX	DECAL POPCORN	1
2	58109	ALL	GLASS, FUN POP 6/8	3



Cabinet Exterior – Rear View

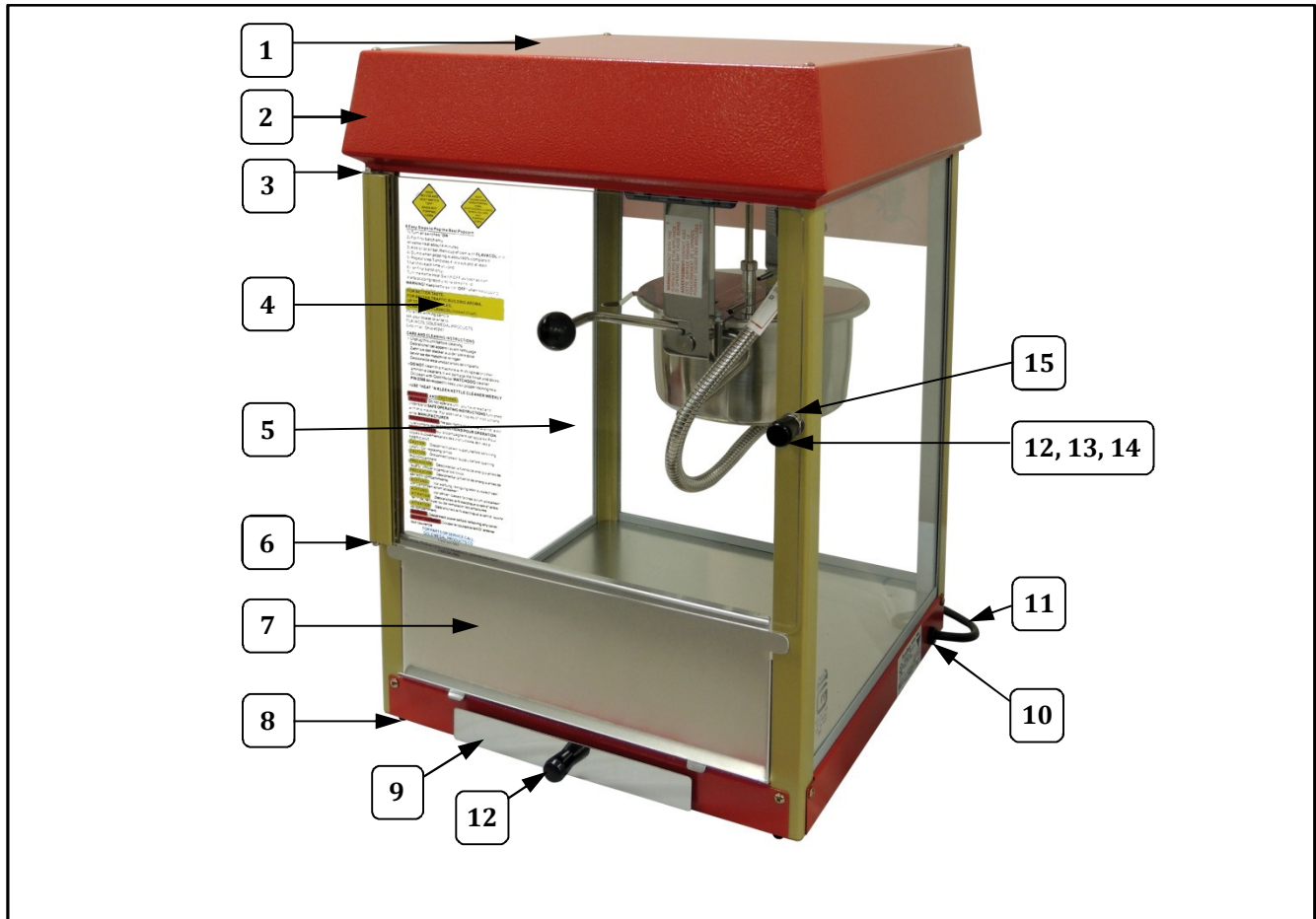

Item	Part No.	Model(s)	Part Description	Qty.
1	58101	2408, 2408EX	DOME COVER FLAT FUN POP	1
2	58104	2408, 2408EX	TOP DOME ASSEMBLY	1
3	55060	ALL	TOP HINGE BRACKET	1
4	41019	ALL	UNIVERSAL POPPER DECAL	1
5	58065	ALL	DOOR ASSEMBLY (includes door, hinge extrusion and pins)	1
6	55061	ALL	BOTTOM HINGE BRACKET	1
7	58113	ALL	DROP PANEL FUN POP 6/8	1
8	87247	ALL	RUBBER BUMPER FOOT	4
9	49100	ALL	OLD MAID PAN	1
10	76026	2408	STRAIN RELIEF	1
	42373	2408EX	IEC SNAP IN RECEPTACLE	
11	22038	2408	LEAD-IN CORD ASSEMBLY	1
	42372	2408EX	POWER CORD IEC SCHUKO	
12	47120	ALL	KNOB LID LIFT	2
13	20066	ALL	8-32 X 1/2 SCREW (for knob)	1
14	50013	ALL	MAGNET	1
15	55104	ALL	LATCH CATCH	1

Cabinet Interior

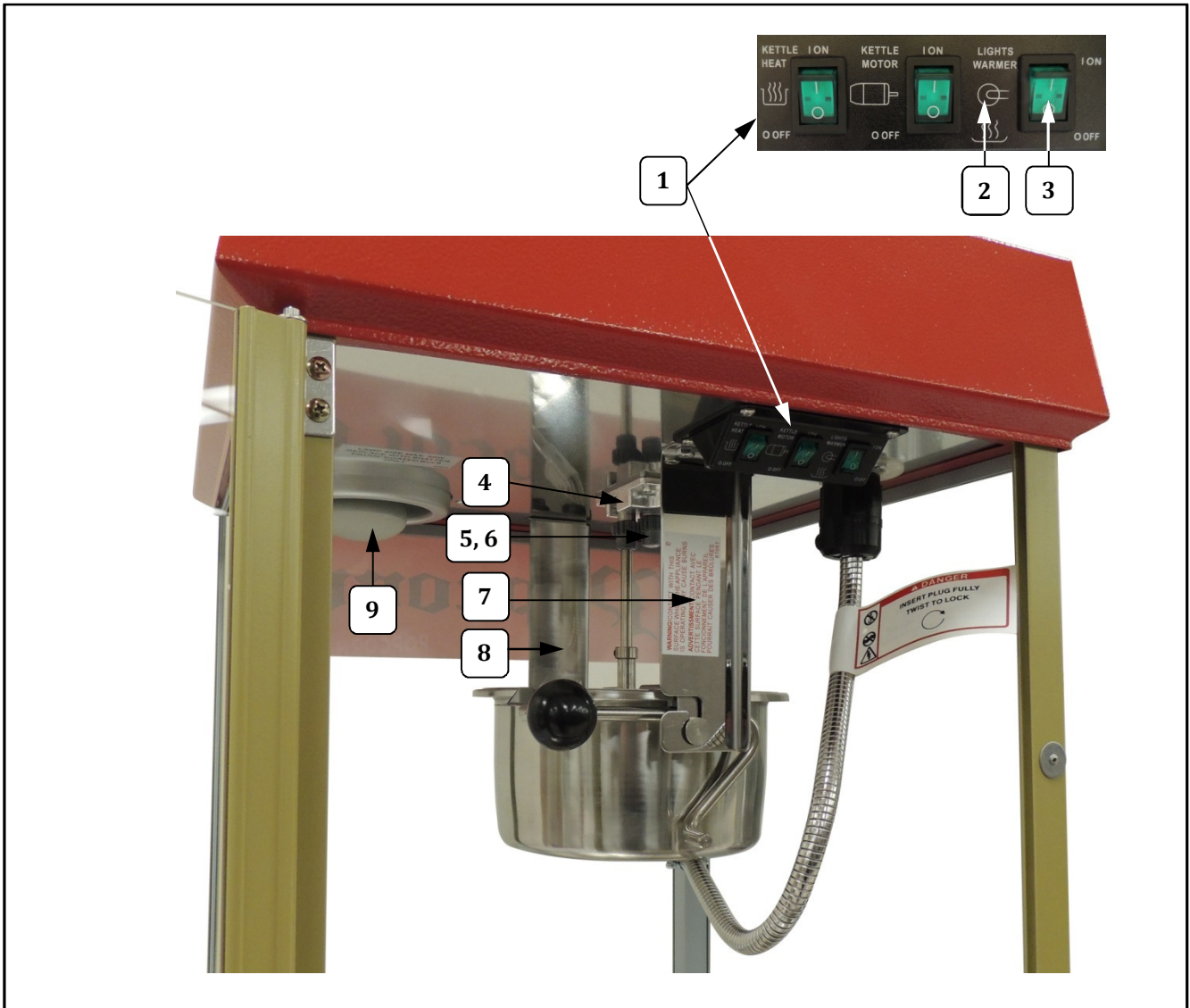

Item	Part No.	Model(s)	Part Description	Qty.
1	55076	ALL	SWITCH MOUNT BOX	1
2	44070	ALL	DECAL, SWITCH MOUNT SMALL	1
3	42532	ALL	DPST ROCKER SWITCH	3
4	67194A	ALL	GEAR BLOCK ASSEMBLY	1
5	47060	ALL	SPUR GEAR	1
6	41742	ALL	SET SCREW #10-32 X 3/16	1
7	49010	ALL	FRONT HANGER ARM	1
8	49009	ALL	REAR HANGER ARM	1
9	42947	2408	50W COATED BULB	1
	13122	2408EX	40W 240V COATED FLOOD	



Cabinet Bottom

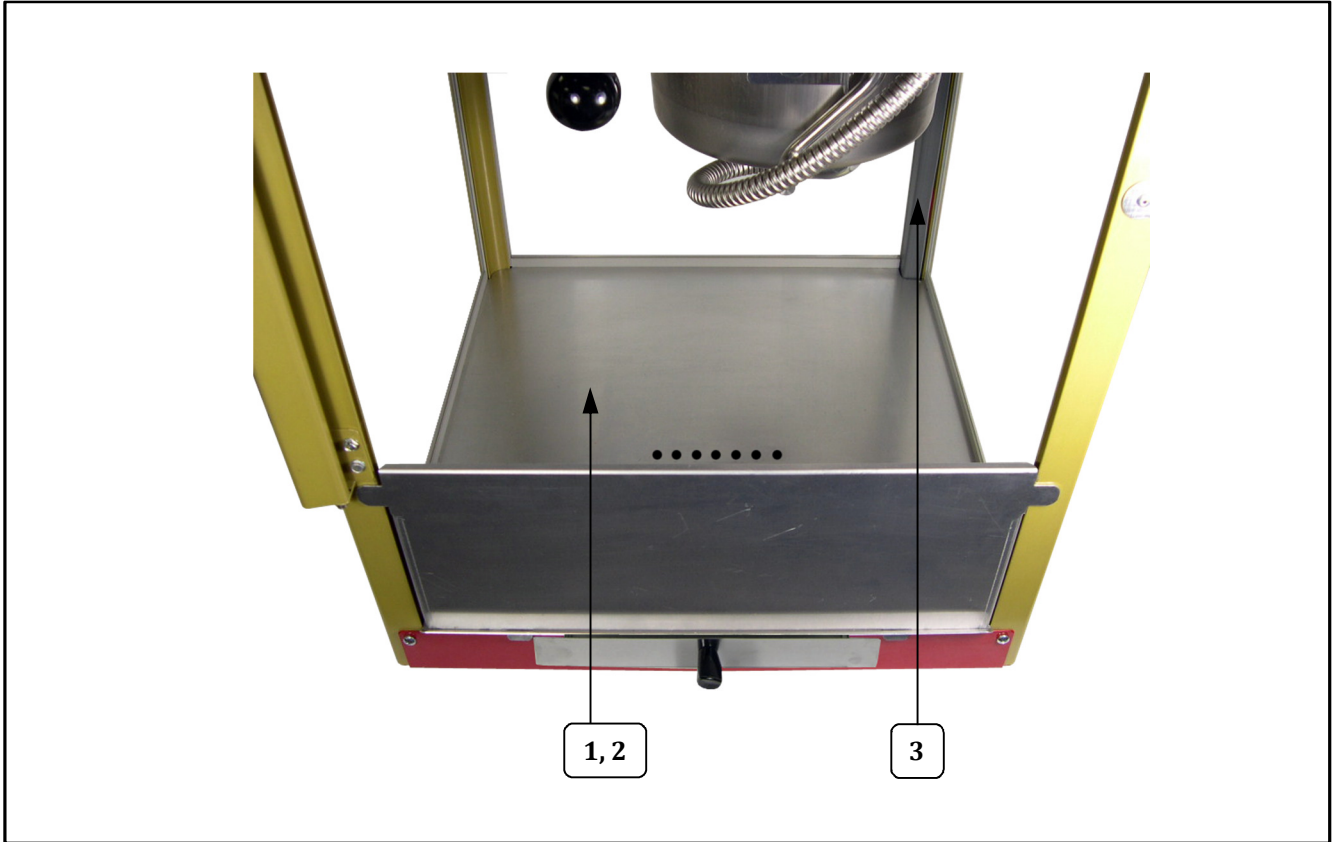

Item	Part No.	Model(s)	Part Description	Qty.
1	58110	ALL	CORN PAN	1
2	40557	2408	120V 20W FOIL HEATER (under corn pan)	1
	40557EX	2408EX	230V 20W FOIL HEATER (under corn pan)	1
3	58077	ALL	WIRE ROUTE COVER	1



Motor Plate

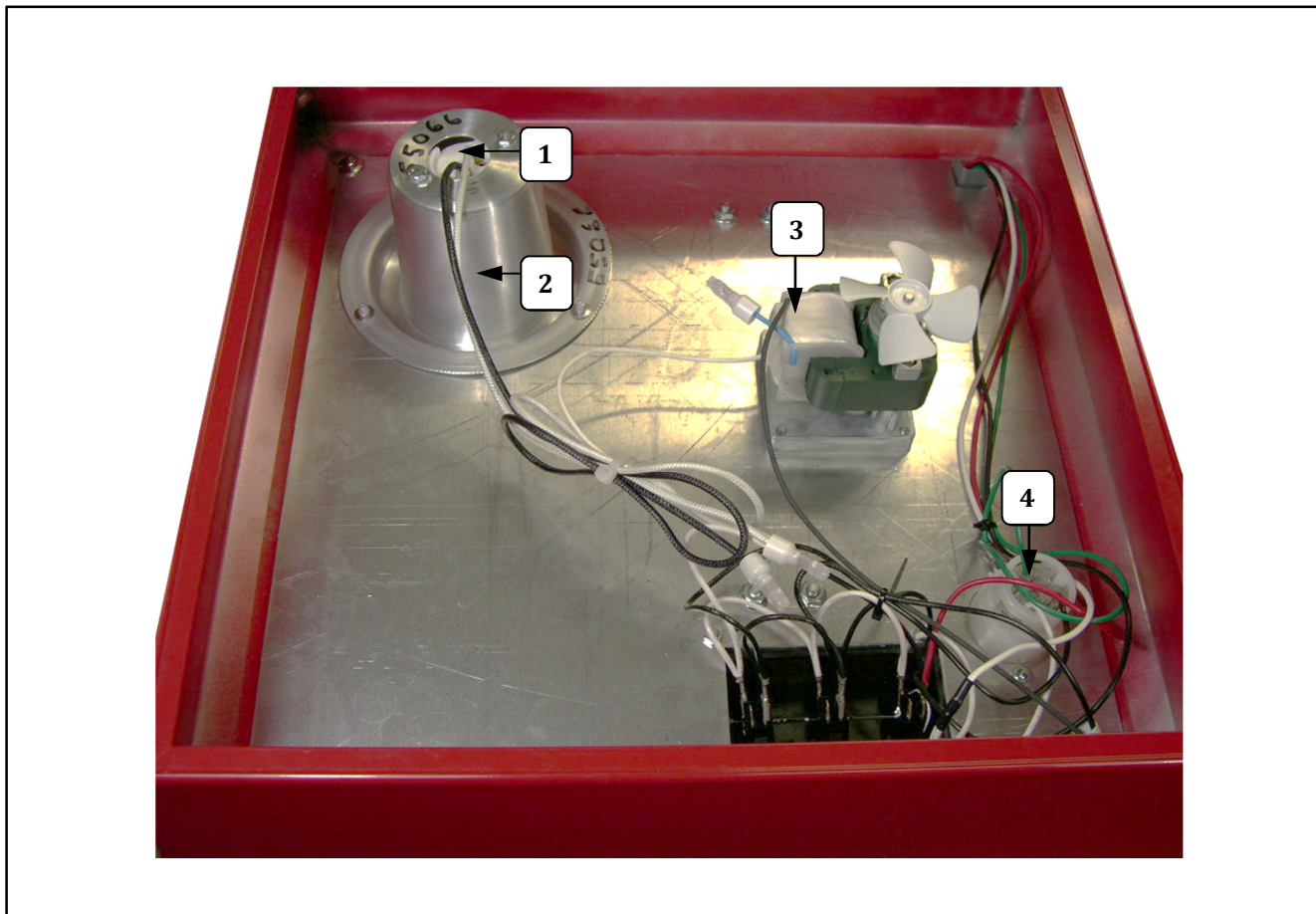

Item	Part No.	Model(s)	Part Description	Qty.
1	56050	ALL	LIGHT BULB SOCKET	1
2	55066	ALL	LIGHT CONE	1
3	47038	2408	KETTLE DRIVE MOTOR 120V	1
	47067	2408EX	KETTLE DRIVE MOTOR 230V	
4	49330	ALL	15A KETTLE RECEPTACLE	1



Kettle Assembly – 8oz. Kettle 58000 (Domestic), 58000EX (Export)

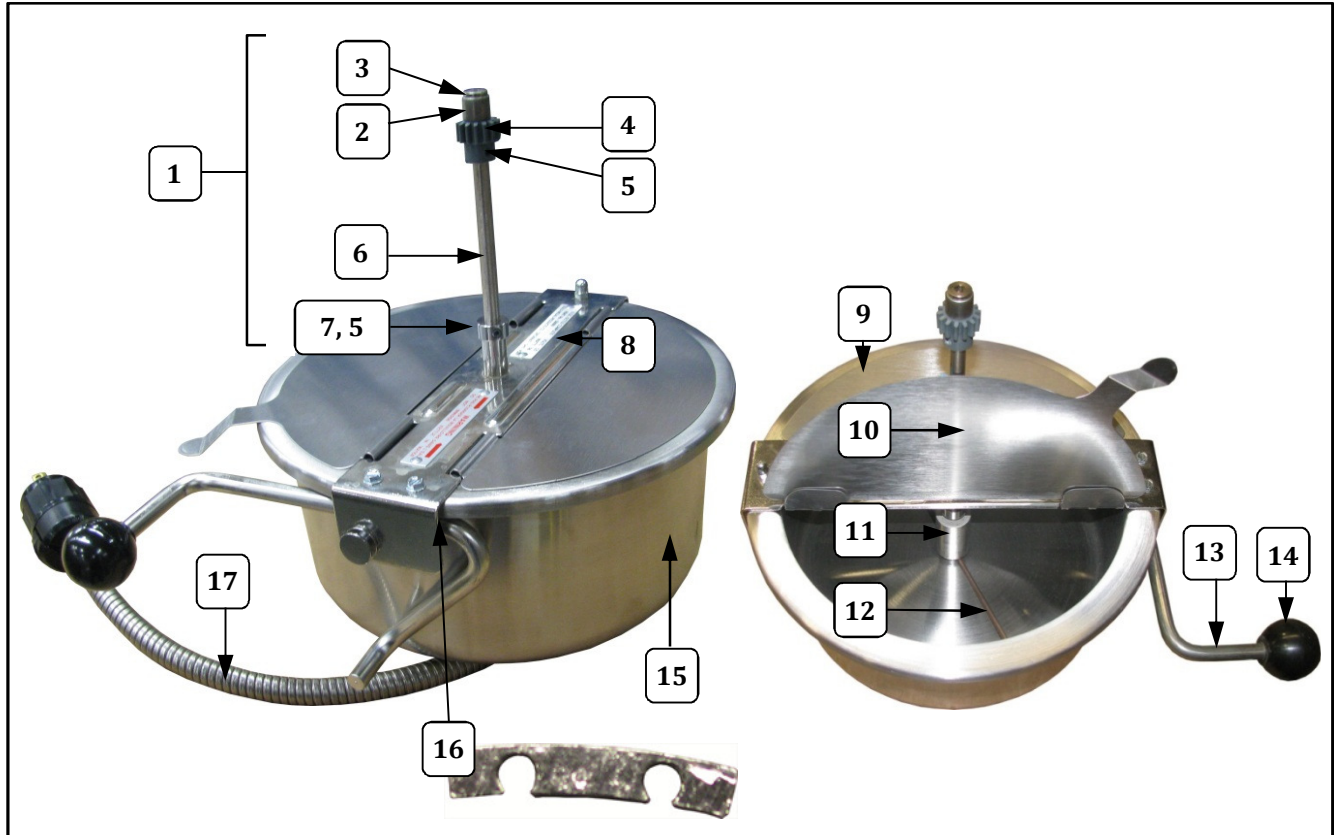

Item	Part No.	Model(s)	Part Description	Qty.
1	59908	58000	LID & AGITATOR ASSY 8OZ (complete assembly - includes crossbar assy)	1
	59908EX	58000EX	LID & AGITATOR ASSY 8OZ (complete assembly - includes crossbar assy)	1
2	47106	ALL	NEEDLE BEARING	1
3	49701	ALL	RETAINING RING	1
4	47060	ALL	SPUR GEAR	1
5	41742	ALL	SET SCREW	4
6	49437	ALL	AGITATOR SHAFT	1
7	46649	ALL	SET COLLAR	3
8	59907	58000	CROSSBAR ASSEMBLY 8OZ.	1
	59907EX	58000EX	CROSSBAR ASSEMBLY 8OZ. EXPORT	
9	49016	ALL	REAR KETTLE LID	1
10	49017	ALL	FRONT LID W/FORMED LIFTER	1
11	49013	ALL	AGITATOR WEIGHT	1
12	49011	ALL	STIR ROD	1
13	49314	ALL	RH DUMP HANDLE	1
14	47110	ALL	KNOB DUMP HANDLE	1
15	49431	ALL	KETTLE SHELL	1
16	49362	ALL	SPACER DUMP HANDLE	1
17	49328	2408	KETTLE LEAD ASSEMBLY	1
	49490	2408EX	EXPORT KETTLE LEAD ASSEMBLY	



Kettle Assembly – 8oz. Kettle 58000 (Domestic), 58000EX (Export)

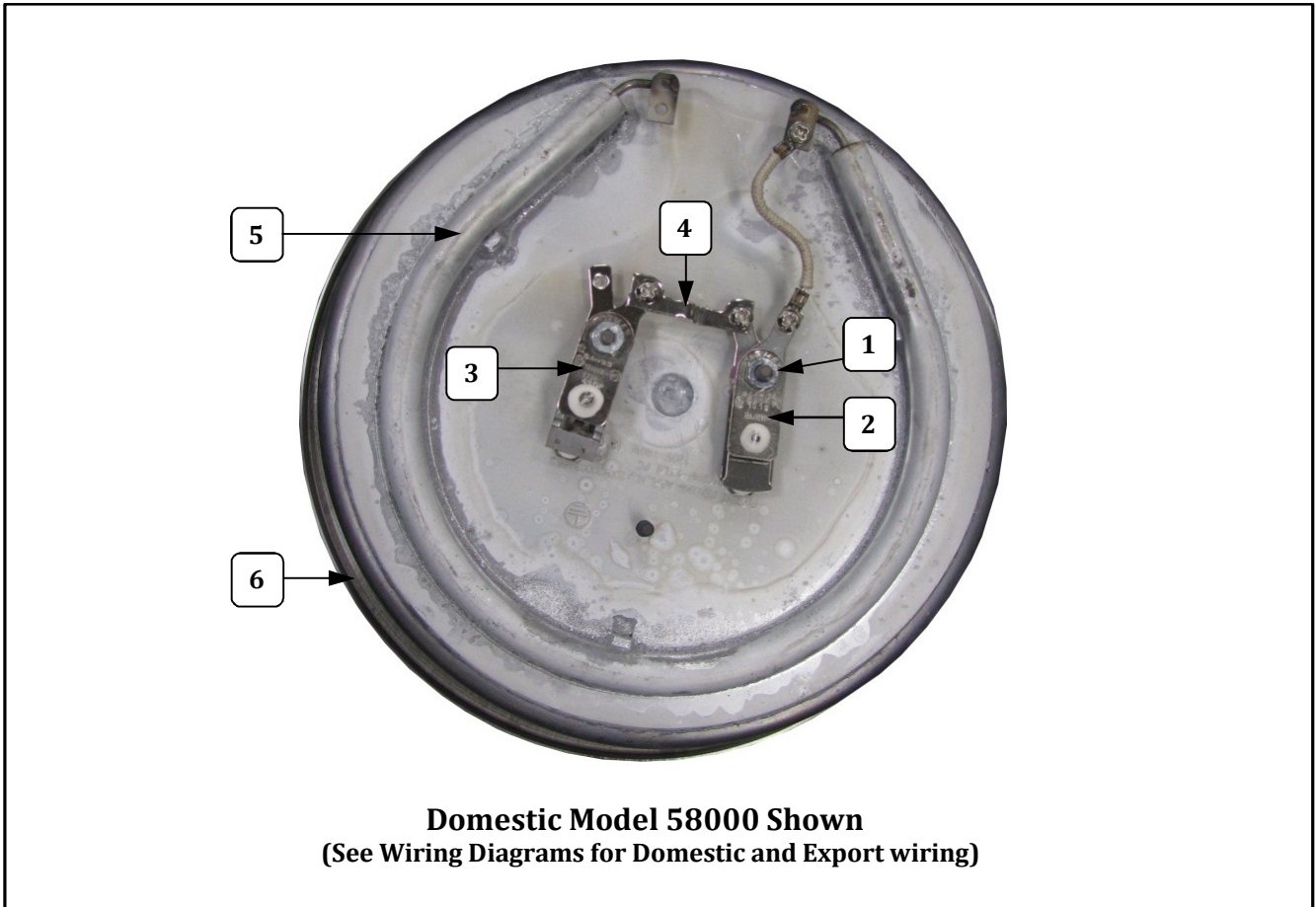

Item	Part No.	Model(s)	Part Description	Qty.
1	67943	ALL	#8-32 TOP LOCK NUT (for thermostat studs)	2
2	76702	58000	THERMOSTAT 525°F	1
3	76089	58000	THERMOSTAT 450°F	1
	76089	58000EX	THERMOSTAT 450°F	2
4	47193	58000	THERMOSTAT SHUNT BAR	1
5	58008	58000	KETTLE/HEATER 8OZ 120V	1
	58008EX	58000EX	KETTLE/HEATER 8 OZ EXPORT	
6	49368	ALL	KETTLE GASKET	1



WIRING DIAGRAMS

Model No. 2408

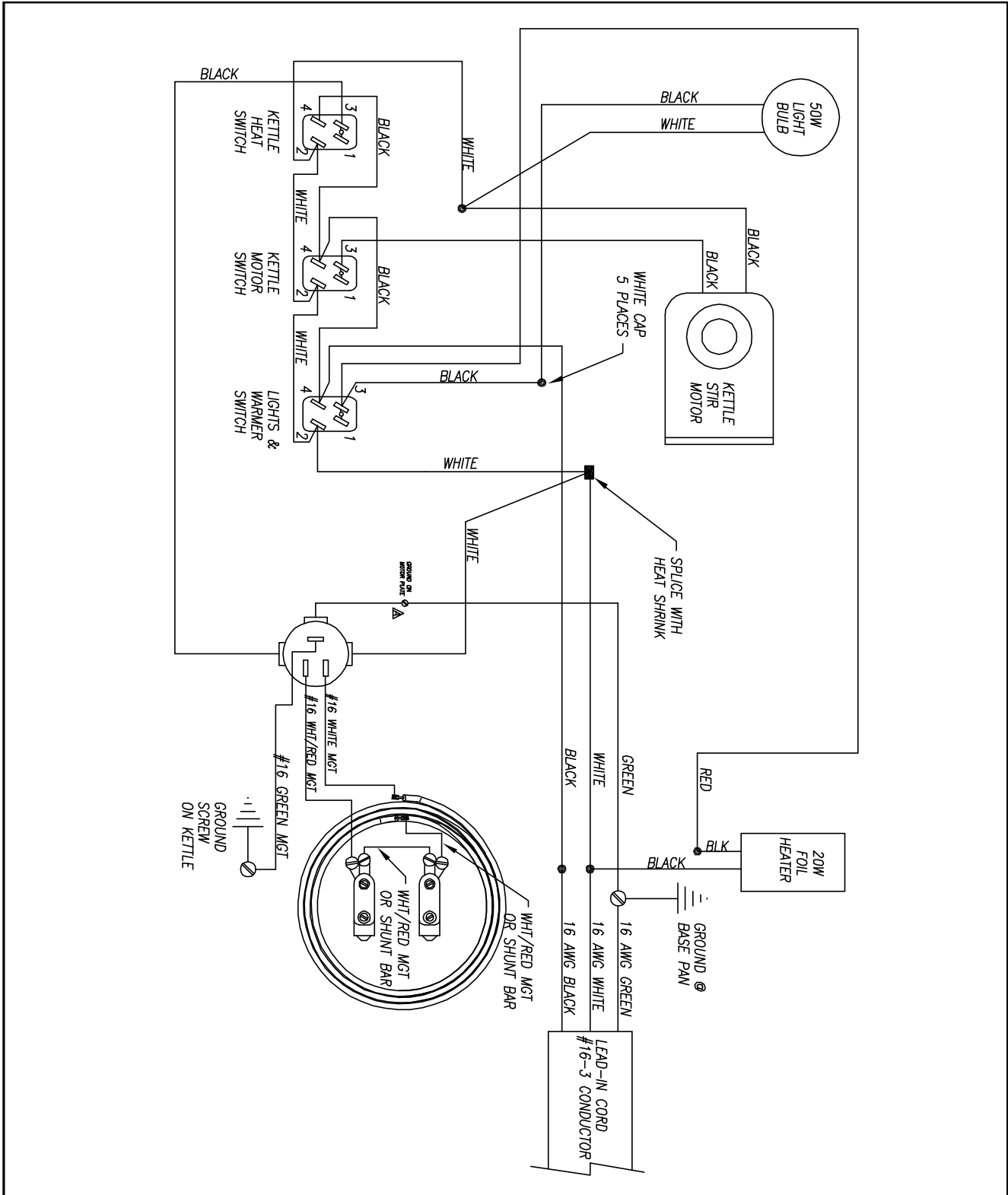



Model No. 2408EX

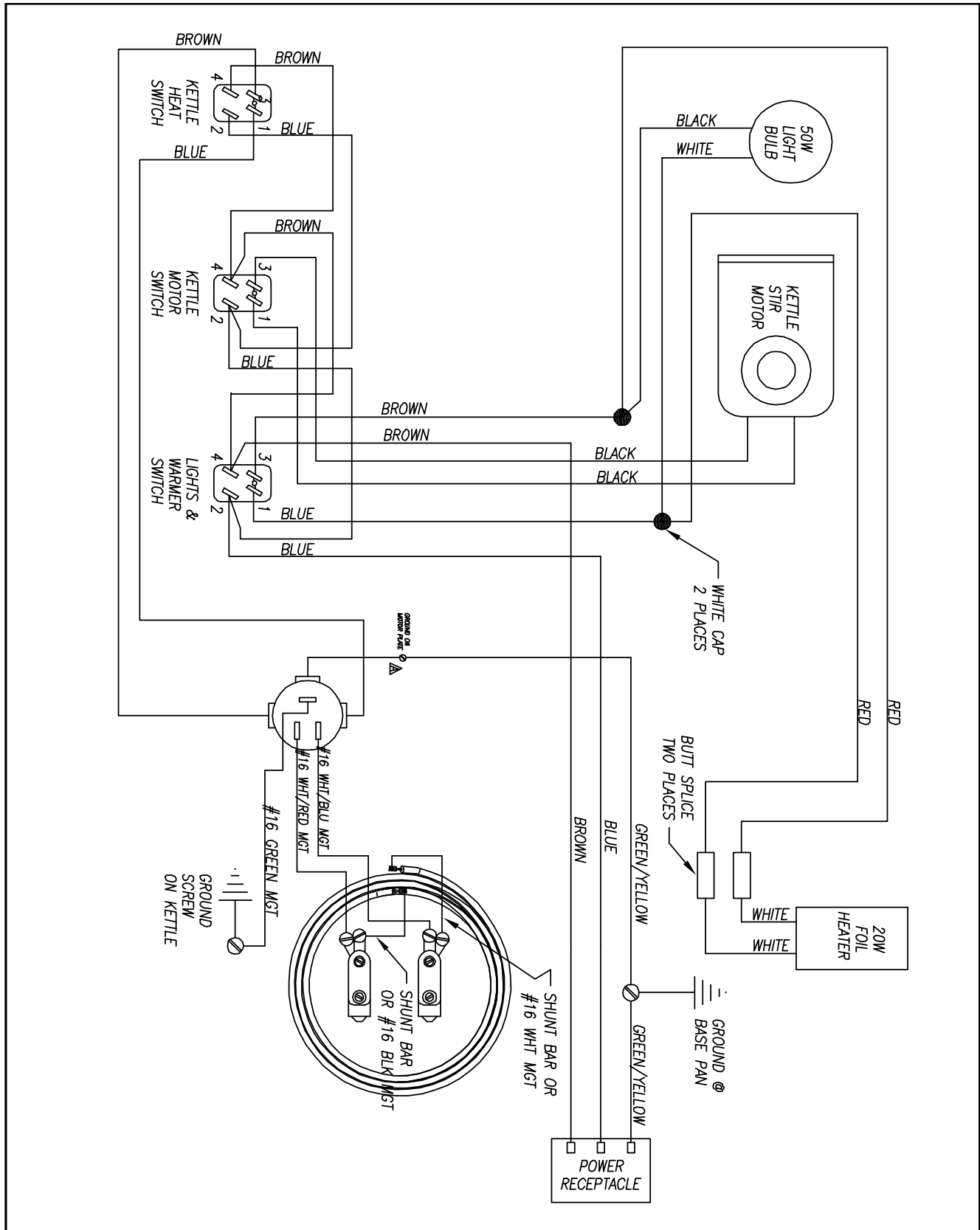



WARRANTY

Gold Medal Products Co. warrants to the original purchaser each item of its manufacture to be free of defects in workmanship and material under normal use and service. Gold Medal Products Co.'s obligation under this warranty is limited solely to repairing or replacing parts, f.o.b. Cincinnati, Ohio, which in its judgment are defective in workmanship or material and which are returned, freight prepaid, to its Cincinnati, Ohio factory or other designated point. Except for "Perishable Parts" on specific machines, the above warranty applies for a period of two (2) years from the date of original sale to the original purchaser of equipment when recommended operating instructions and maintenance procedures have been followed. These are packed with the machine. Parts warranty is two (2) years, labor is six (6) months.

THIS WARRANTY IS IN LIEU OF ALL OTHER WARRANTIES EXPRESSED OR IMPLIED, AND OF ALL OTHER OBLIGATIONS OR LIABILITIES ON OUR PART, INCLUDING THE IMPLIED WARRANTY OF MERCHANTABILITY. THERE ARE NO WARRANTIES WHICH EXTEND BEYOND THE DESCRIPTION ON THE FACE HEREOF. In no event shall Gold Medal Products Co. be liable for special, incidental or consequential damages. No claim under this warranty will be honored if the equipment covered has been misused, neglected, damaged in transit, or has been tampered with or changed in any way. No claim under this warranty shall be honored in the event that components in the unit at the time of the claim were not supplied or approved by Gold Medal Products Co. This warranty is effective only when electrical items have been properly attached to city utility lines only at proper voltages. This warranty is not transferable without the written consent of Gold Medal Products Co.

The term "Original Purchaser" as used in this warranty shall be deemed to mean that person, firm, association, or corporation who was billed by the GOLD MEDAL PRODUCTS CO., or their authorized distributor for the equipment.

THIS WARRANTY HAS NO EFFECT AND IS VOID UNLESS THE ORIGINAL PURCHASER FIRST CALLS GOLD MEDAL PRODUCTS CO. AT 1-800-543-0862 TO DISCUSS WITH OUR SERVICE REPRESENTATIVE THE EQUIPMENT PROBLEM, AND, IF NECESSARY, FOR INSTRUCTIONS CONCERNING THE REPAIR OR REPLACEMENT OF PARTS.

NOTE: This equipment is manufactured and sold for commercial use only.



GOLD MEDAL[®] PRODUCTS CO.

10700 Medallion Drive, Cincinnati, Ohio 45241-4807 USA

gmpopcorn.com

Phone: (800) 543-0862 Fax: (800) 542-1496
(513) 769-7676 (513) 769-8500